

# Bluetooth LE Module MS88SF3

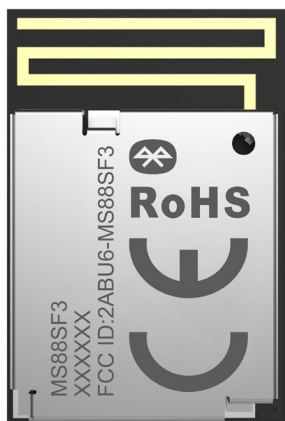

Datasheet  
V 1.0.0



## Version Note

Version	Details	Contributor(s)	Date	Notes
1.0.0	First edit	Michelle, Leo	2024.05.06	

## Part Number

Model	Hardware Code
MS88SF31	1Y40AI

Click the icon to view and download the latest product documents electronically.  
[https://en.minewsemi.com/file/MS88SF3-nRF52840\\_Datasheet\\_K\\_EN.pdf](https://en.minewsemi.com/file/MS88SF3-nRF52840_Datasheet_K_EN.pdf)



# MS88SF3-nRF52840

## High-performance, Full I/O port, multi-protocol Bluetooth 5.4 module

The MS88SF3 is a low-power, cost-effective wireless BLE 5.4 module based on the nRF52840 SoC. Its powerful 32-bit ARM Cortex™ M4F CPU, 1M FLASH program space, 256kB RAM, integrated 2.4 GH transceiver, and other powerful supporting resources provide the perfect solution for Bluetooth connectivity. nRF52840 can support protocols such as ANT, BLE, BLE MESH, ZIGBEE, and THREAD. With a built-in PA/LNA, it has an estimated range of up to 250 meters in open space at a data rate of 125kbps.

### FEATURES



Bluetooth 5.4



High-performance



Leads 48 I/O ports



Support ANT, BLE, BLE MESH, ZIGBEE and THREAD protocols, etc

### KEY PARAMETER

MS88SF3-nRF52840			
Chip Model	nRF52840	Antenna	PCB
Module Size	18.5×12.5×2mm	GPIO	48
Flash	1M	RAM	256KB
Receiving Sensitivity	-95dBm(1Mbps) -103dBm(125kbps)	Transmission Power	-40 ~ +8dBm
Current(TX)	0dBm-4.8mA	Current(RX)	4.6mA

### APPLICATION



Smart Buildings



Consumer Electronics



Intelligent Medical care



Smart Agriculture



Security Equipment



Automotive Equipment

### CERTIFICATION



REACH

RoHS



# INDEX

1.Block Diagram .....	05
2.Electrical Specification .....	05
3.Pin Description .....	06
4.Pin Definition .....	06
5.Mechanical Drawing .....	07
6.Electrical Schematic .....	07
7.PCB Layout .....	08
8.Reflow and Soldering.....	08
9.Package Information .....	09
10.Storage Conditions .....	10
11.Handling Conditions.....	10
12.Quality .....	10
13.Copyright Statement.....	11
14.Related Documents .....	11

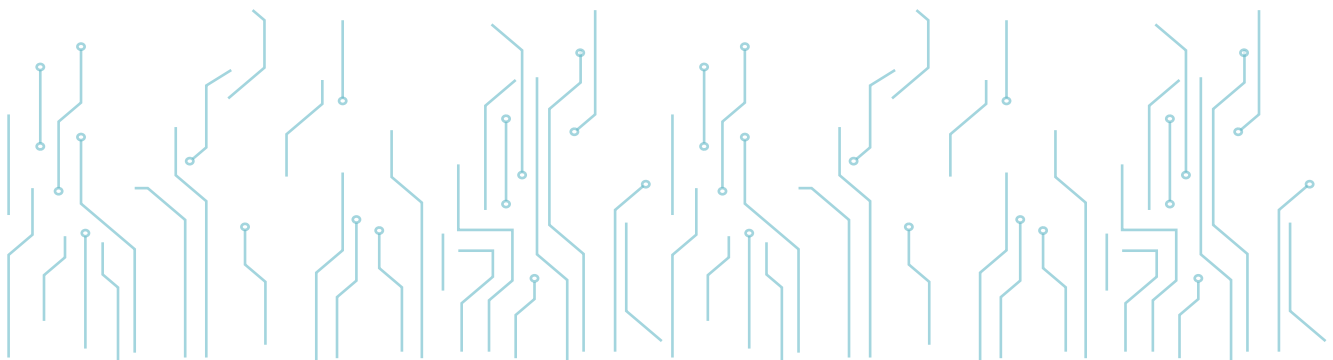

# 1 BLOCK DIAGRAM

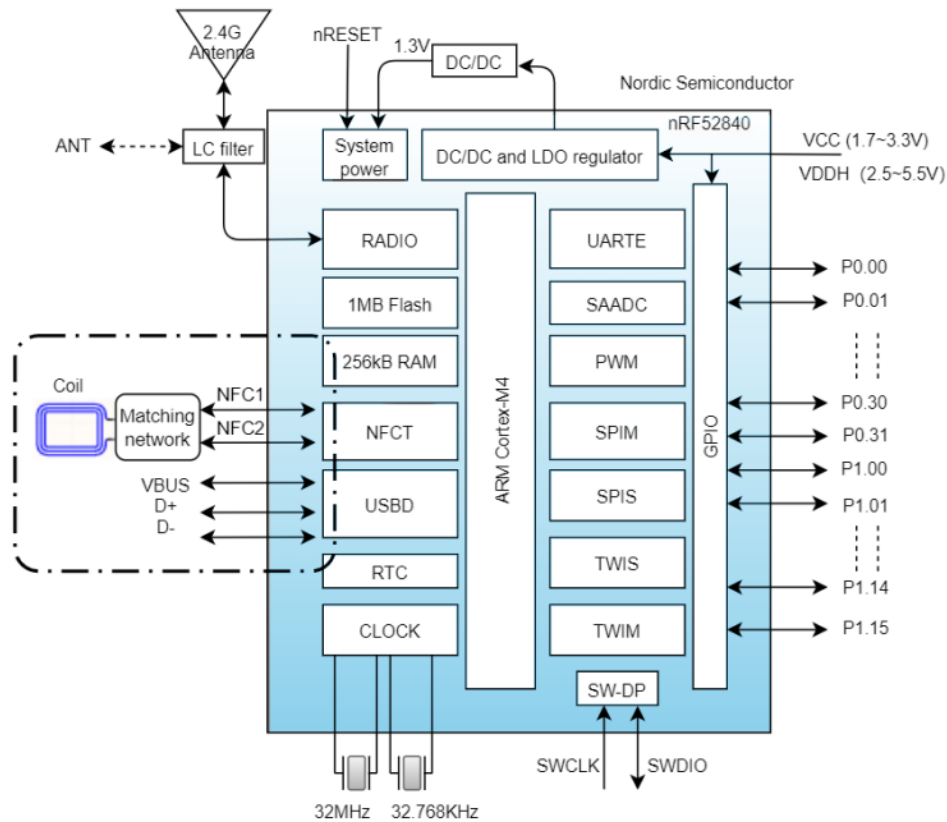

# 2 ELECTRICAL SPECIFICATION

Parameters	Value	Notes
Working Voltage	1.7V-5.5V	To ensure RF work, supply voltage suggest not lower than 2.3V
Working Temperature	-40 C ~+85 C	Storage temperature is -40 C ~+125 C
Transmission Power	-40 ~ +8dBm	Configurable
Current(RX)	4.6mA	RF receiving current under 1Mbps pattern
Current(TX)	4.8mA	RF transmission current under odB pattern
Module Dimension	18.5*12.5*2mm	
Quantity of IO Port	48	

### 3 PIN DESCRIPTION

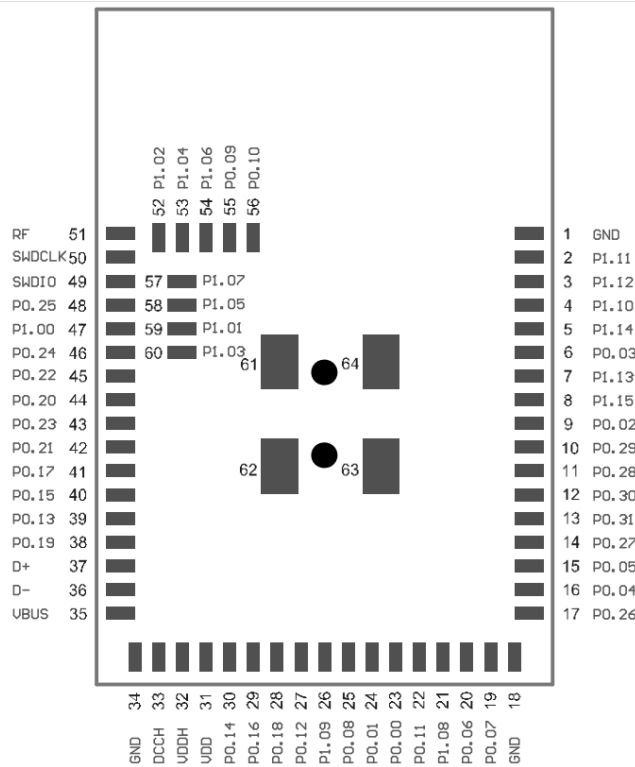

### 4 PIN DEFINITION

Pin Number	Symbol	Type	Definition
1/18/34	GND	ground	ground
50/49	SWCLK / SWDIO	Burn Pins	Burn pins, burn only need to connect the power supply pin, ground, and these two pins
2-17/19-30/38-48/52-60	P0.02-P0.31 P1.00-P1.09	I/O	General Purpose I/O Port
31	VDD	power	Power supply, 1.7V-3.6V, use this pin for power supply, need to short VDD and VDDH
32	VDDH	power	Power supply, 2.5V-5.5V, use this pin for power supply, not connected to VDD pin
33	DCCH	power	DC/DC converter output
35	VBUS	power	USB Power Supply, 4.35V-5.5V
37	D+	Digital interfaces	USB D+
36	D-	Digital interfaces	USB D-
51	RF	External Antenna Pin	By default, the module comes with an antenna, this pin is directly suspended. If you don't use the module antenna, you can connect an external antenna through this pin, when connecting an external antenna, the module needs to connect the resistor with the antenna to this pin..
61-64	NC	NC	NC, or Ground



# 7 PCB LAYOUT

There should be no GND plane or metal cross wiring in the module antenna area, and components should not be placed nearby. It is best to make a hollow or clear area, or place it on the edge of the PCB board.

 Notice: Refer to examples as below, and highly suggest to use the first design and the adjustment of modules antenna design according to the first wiring.

**Layout Notes:**

- 1) Preferred Module antenna area completely clearance and not be prevented by metals, otherwise it will influence antenna's effect (as above DWG. indication).
- 2) Cover the external part of module antenna area with copper as far as possible to reduce the main board's signal cable and other disturbing.
- 3) It is preferred to have a clearance area of 4 square meter or more area around the module antenna (including the shell) to reduce the influence to antenna.
- 4) Device should be grounded well to reduce the parasitic inductance.
- 5) Do not cover copper under module's antenna in order to avoid affect signal radiation or lead to transmission distance affected.
- 6) Antenna should keep far from other circuits to prevent radiation efficiency reduction or affects the normal operation of other lines.
- 7) Module should be placed on edge of circuit board and keep a distance away from other circuits.
- 8) Suggesting to use magnetic beads to insulate module's access power supply.



# 8 REFLOW AND SOLDERING

1) Do SMT according to above reflow oven temperature deal curve. Max. Temperature is 260 °C; Refer to IPC/JEDEC standard; Peak TEMP < 260 °C; Times: ≤ 2 times, suggest only do once reflow soldering on module surface in case of SMT double pad involved. Contact us if special crafts involved.

- 2) Suggesting to make 0.2mm thickness of module SMT for partial ladder steel mesh, then make the opening extend 0.8mm
- 3) After unsealing, it cannot be used up at one time, should be vacuumed for storage, couldn't be exposed in the air for long time. Please avoid getting damp and soldering-pan oxidizing. If there are 7 to 30 days interval before using online SMT, suggest to bake at 65-70 °C for 24 hours without disassembling the tape.
- 4) Before using SMT, please adopt ESD protection measure.

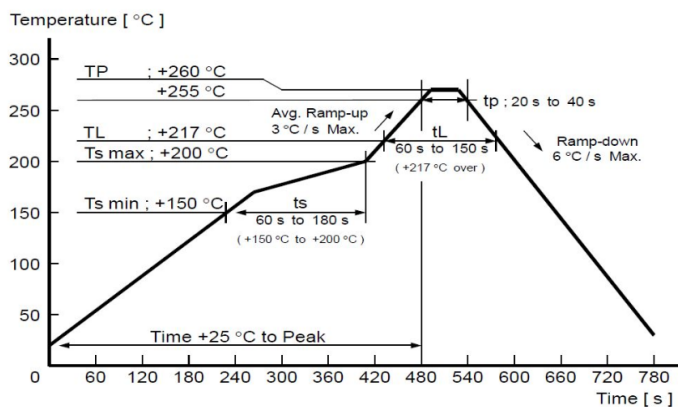



# 9 PACKAGE INFORMATION

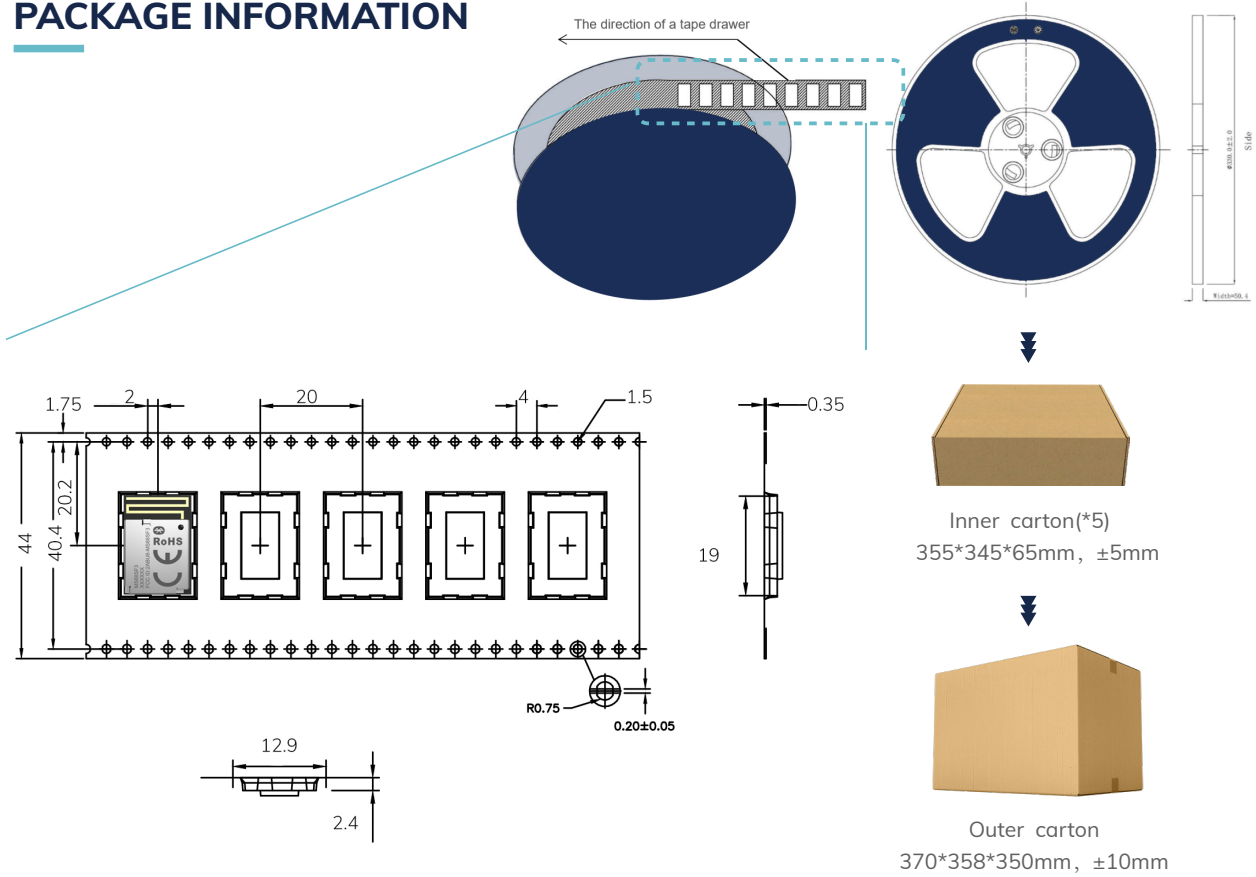

## Remarks

General material list for FCL packaging:



Carrier tape packaging tray

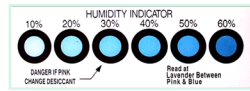

Humidity Indicator (1 pcs/bag)



Desiccant (placed in a vacuum bag)



Vacuum bag



Inner carton(\*5)  
355\*345\*65mm, ±5mm



Outer carton  
370\*358\*350mm, ±10mm

### Other:

Moisture-proof label (attached to the vacuum bag)

Certification label (attached to the vacuum bag)

Outer box label

Default unit: mm Default tolerance: ±0.1

Packing detail	Specification	Net weight	Gross weight	Dimension
MS88SF3	850PCS	680g	1537g	W=44mm, T=0.35mm

Note: Default weight tolerance all are within 10g (except the special notes)

## 10 STORAGE CONDITIONS

- Please use this product within 6 months after signing the receipt.
  - This product should be stored without opening the package at an ambient temperature of 5~35°C and a humidity of 20~70%RH.
  - This product should be left for more than 6 months after receipt and should be confirmed before use.
  - The product must be stored in a non-corrosive gas (Cl<sub>2</sub>, NH<sub>3</sub>, SO<sub>2</sub>, NO<sub>x</sub>, etc.).
  - To avoid damaging the packaging material, do not apply any excessive mechanical shocks, including but not limited to sharp objects adhering to the packaging material and product dropping.
- This product is suitable for MSL2 (based on JEDEC standard J-STD-020).
  - After opening the package, the product must be stored at ≤30°C/<60%RH. It is recommended to use the product within 3-6 months after opening the package.
  - When the color of the indicator in the package changes, the product should be baked before welding.
- Baking is not required for one year if exposure is limited to <30°C and 60%RH. Refer to MSL2 for exposure criteria for moisture sensitivity level. If exposed to (≥168h@85°C/60%RH) conditions or stored for more than one year, recommended baking conditions.
  1. 120 ±5/-5°C, 8 hours, 1 time  
Products must be baked individually on heat-resistant trays because the materials (base tape, reel tape, and cover tape) are not heat-resistant, and the packaging material may be deformed at temperatures of 120 °C;
  2. 90 °C ±8/-0 °C, 24hours, 1times  
The base tape can be baked together with the product at this temperature. Please pay attention to the uniformity of heat.

## 11 HANDLING CONDITIONS

- Be careful in handling or transporting products because excessive stress or mechanical shock may break products.
- Handle with care if products may have cracks or damages on their terminals. If there is any such damage, the characteristics of products may change. Do not touch products with bare hands that may result in poor solder ability and destroy by static electrical charge.

## 12 QUALITY

Cognizant of our commitment to quality, we operate our own factory equipped with state-of-the-art production facilities and a meticulous quality management system. We hold certifications for ISO9001, ISO14001, ISO27001, OHSAS18001, BSCI.

Every product undergoes stringent testing, including transmit power, sensitivity, power consumption, stability, and aging tests. Our fully automated module production line is now in full operation, boasting a production capacity in the millions, capable of meeting high-volume production demands.

## 13 COPYRIGHT STATEMENT

This manual and all the contents contained in it are owned by Shenzhen Minewsemi Co., Ltd. and are protected by Chinese laws and applicable international conventions related to copyright laws.

The certified trademarks included in this product and related documents have been licensed for use by MinewSemi. This includes but is not limited to certifications such as BQB, RoHS, REACH, CE, FCC, BQB, IC, SRRC, TELEC, WPC, RCM, WEEE, etc. The respective textual trademarks and logos belong to their respective owners. For example, the Bluetooth® textual trademark and logo are owned by Bluetooth SIG, Inc. Other trademarks and trade names are those of their respective owners. Due to the small size of the module product, the "®" symbol is omitted from the Bluetooth Primary Trademarks information in compliance with regulations.

The company has the right to change the content of this manual according to the technological development, and the revised version will not be notified otherwise. Without the written permission and authorization of the company, any individual, company, or organization shall not modify the contents of this manual or use part or all of the contents of this manual in other ways. Violators will be held accountable in accordance with the law.

## 14 RELATED DOCUMENTS

- nRF52840\_Chip\_Datasheet  
[https://en.minewsemi.com/file/nRF52840\\_Chip\\_Datasheet\\_EN.pdf](https://en.minewsemi.com/file/nRF52840_Chip_Datasheet_EN.pdf)
- MinewSemi\_Product\_Naming\_Reference\_Manual\_V1.0  
[https://en.minewsemi.com/file/MinewSemi\\_Product\\_Naming\\_Reference\\_Manual\\_EN.pdf](https://en.minewsemi.com/file/MinewSemi_Product_Naming_Reference_Manual_EN.pdf)
- MinewSemi\_Connectivity\_Module\_Catalogue\_V2.0  
[https://en.minewsemi.com/file/MinewSemi\\_Connectivity\\_Module\\_Catalogue\\_EN.pdf](https://en.minewsemi.com/file/MinewSemi_Connectivity_Module_Catalogue_EN.pdf)



For product change notifications and regular updates of Minewsemi documentation, please register on our website: [www.minewsemi.com](http://www.minewsemi.com)

# MINEWSEMI



### SHENZHEN MINEWSEMI CO., LTD.

-  0086-755-2801 0353
-  <https://minewsemi.com>
-  [minewsemi@minew.com](mailto:minewsemi@minew.com)
-  <https://store.minewsemi.com>
-  No.8, Qinglong Road, Longhua District, Shenzhen, China