

# USB Bluetooth Dongle ME91BK01



Datasheet  
V 1.0.0



## Version Note

Version	Details	Contributor(s)	Date	Notes
1.0.0	First edit	Michelle	2026.01.22	

## Part Number

Model	Hardware Code
ME91BK01	-

Click the icon to view and download the latest product documents electronically.  
[https://en.minewsemi.com/file/ME91BK01\\_Datasheet\\_M\\_EN.pdf](https://en.minewsemi.com/file/ME91BK01_Datasheet_M_EN.pdf)



# ME91BK01-Bluetooth Dongle

## Supports master-slave switching, UART command configuration, and iBeacon broadcasting mode

The ME91BK01 is a USB Bluetooth Dongle for the ME54BS12-nRF54L15 module. It supports switching between master and slave modes by either holding the button for 2 seconds or using commands. Master and slave modes cannot operate simultaneously, and only one-to-one connections are supported. The device defaults to master mode.

In master mode, it can scan and connect to devices via commands. The scan can be configured with broadcast name filters and MAC address filters to identify specific devices. Connections can only be initiated using a designated MAC address.

The adapter communicates with an MCU through the UART interface. In command mode, UART commands can be used to adjust parameters such as scan interval, scan timeout, connection interval, advertising interval, custom advertising data, and baud rate.

It is suitable for developing and testing Nordic-based wireless solutions.

## FEATURES



Support master-slave switching via button or command



Built-in indicator LED



One-to-one connection



Supports UART command configuration



Supports iBeacon broadcasting mode

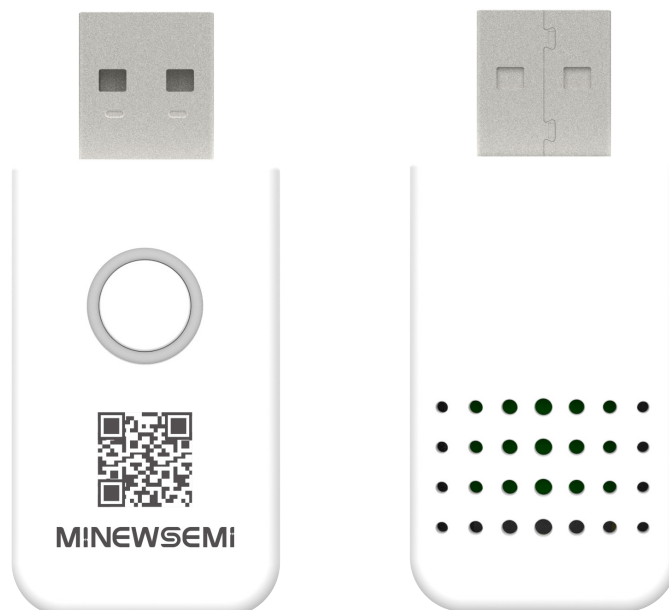

# INDEX

1 Block Diagram .....	05
2 Electrical Specification .....	05
3 Current Consumption Characteristics .....	06
4 Pin Description .....	06
5 Device Definition .....	07
6 Module Operation Instructions .....	08
6.1 Tool .....	08
6.1.1 Command Instructions .....	08
6.2 Operation Examples .....	13
6.2.1 Factory Default Parameters .....	13
6.2.2 Parameter Modification Example .....	14
6.2.3 Scanning and Connecting to Devices .....	14
6.2.4 Master Pass-Through .....	15
6.2.5 Slave Broadcasting .....	16
6.2.6 Slave Pass-Through .....	18
6.3 OTA Operating Instructions .....	19
6.3.1 Configuring the nRF Connect App .....	19
6.3.2 Connecting and Performing the Upgrade .....	20
7 Mechanical Drawing .....	21
8 Electrical Schematic .....	21
9 Package Information .....	22
10 Storage Conditions .....	22
11 Handling Conditions .....	23
12 Quality .....	23
13 Copyright Statement .....	23
14 Related Documents .....	23

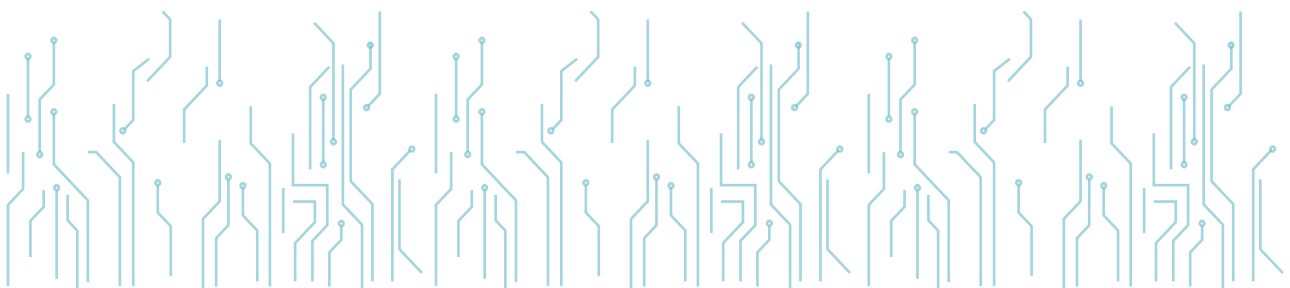

# 1 BLOCK DIAGRAM

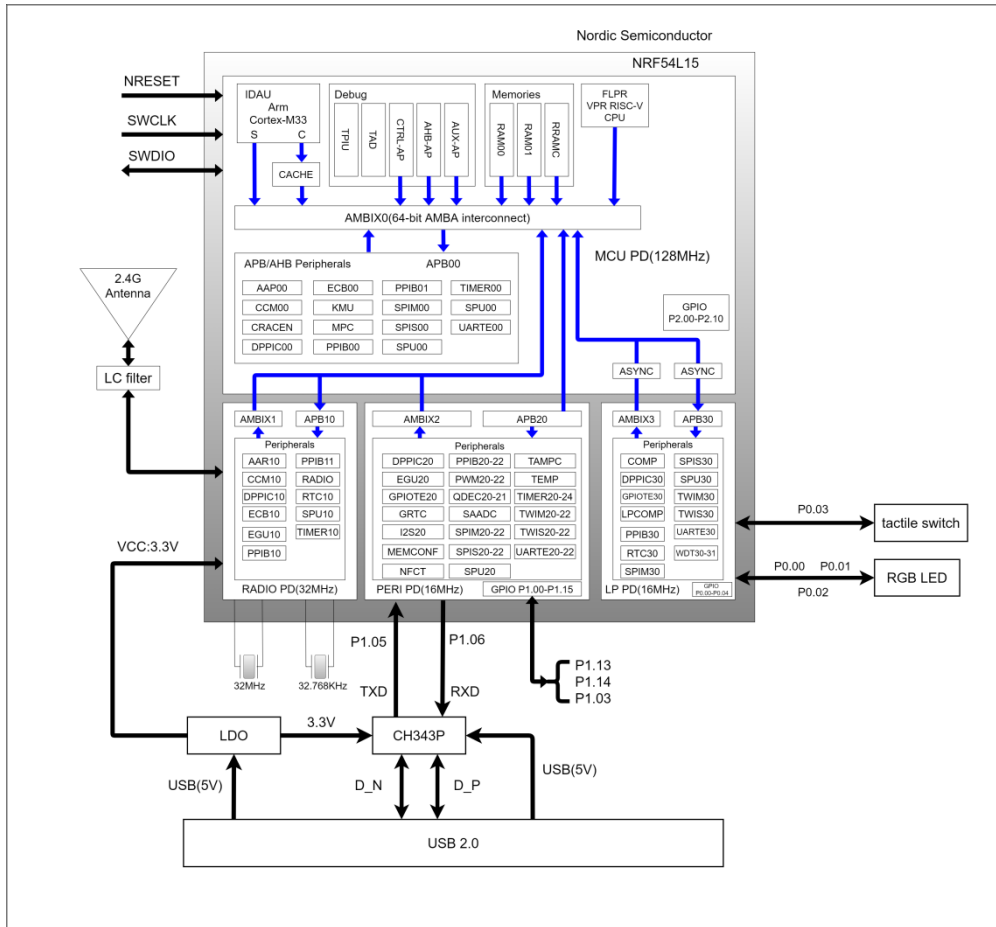

# 2 ELECTRICAL SPECIFICATION

Model	ME91BK01
Color	White
Dimensions	50*24*10.5 mm
Weight	9.2g
Power supply	USB power supply (DC 5V 1A)
Installation method	Connect via the standard Type A USB port of the computer
Operating temperature	-20~55℃

### 3 CURRENT CONSUMPTION CHARACTERISTICS

In slave mode, the power consumption is as follows: (broadcast interval is 1 s, connection interval is 20 ms, transmission power is 0 dBm).

Status	Consumption	Peak(mA)	Avg( $\mu$ A)
	Average broadcast current (connected to VCC and GND)	6.56	136.96
	Average current in connected state (connected to VCC and GND)	3.33	182.75
	Average current in transparent transmission mode (powered via VCC and GND, connected to a mobile phone, baud rate 115200, 200 bytes per transmission, every 20 ms)	6.82	396.29

When in master mode, the power consumption is as follows:

Status	Consumption	Peak(mA)	Avg(mA)
	Average current during scanning	6.75	3.94
	Average current in transparent transmission mode (powered via VCC and GND, connected to a slave module, baud rate 115200, 200 bytes per transmission, every 20 ms)	6.74	927.22 ( $\mu$ A)

### 4 PIN DESCRIPTION

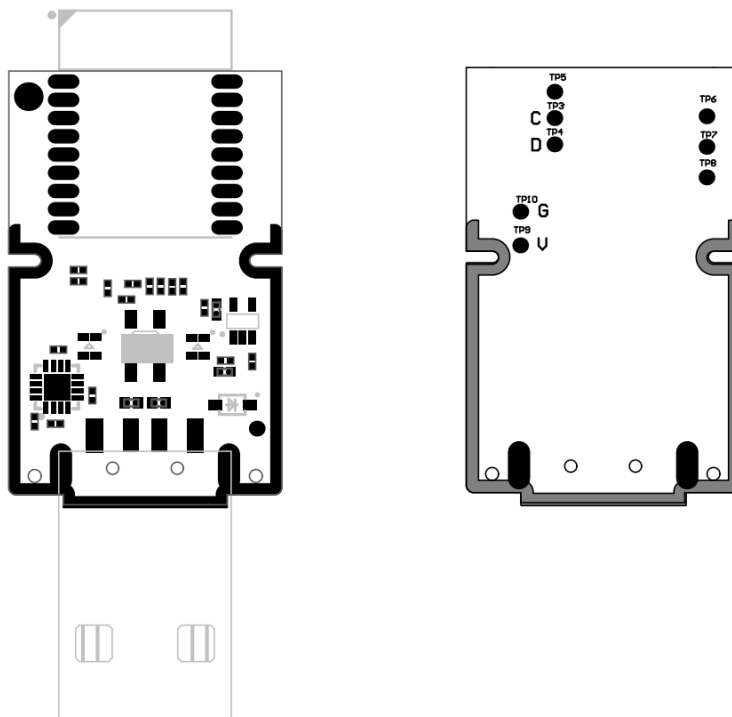

# 5 PIN DEFINITION

Name	Definition	Function Description
Button	Switch master/slave mode	Press and hold for 2 seconds to switch between master and slave modes.
		If the current (master/slave) mode is connected, pressing and holding for two seconds will disconnect the current connection and force a switch.
LED	Power-on	The red, green, and blue indicator lights will light up in sequence for one second each.
	Blue light - Master mode	Solid blue when connected, blinking blue when disconnected.
	Green light - Slave mode	Solid green when connected, blinking green when disconnected.
	【Red light】 - FIFO full indicator	The FIFO pin indicates whether the UART receive buffer has space. The red light control pin replaces the FIFO indicator pin. When the FIFO is full, it lights up along with the current master/slave role indicator (orange).
TP3	SWDCLK	Programming data pin, used for programming firmware
TP4	SWDIO	Programming data pin, used for programming firmware
TP5	P0.21	GPIO
TP6	P0.29	GPIO
TP7	P0.30	GPIO
TP8	P0.10	GPIO
TP9	3V3	Power supply
TP10	GND	GND

 Note: Note: TP3–TP10 are internal PCB connections mapped to the corresponding pins of the ME54BS12-nRF54L15 module. For detailed definitions of all module pins, please refer to the module datasheet.

# 6 MODULE OPERATION INSTRUCTION

## 6.1 Tool

PC serial port assistant: Search and download "Serialport Utility" in your browser. The PC serial port assistant is used to debug the UART interface of the module.

### 6.1.1 Command Instructions

After powering on the Dongle, the status indicator LEDs (red, green, and blue) will light up sequentially for one second. At this point, the module is in an unconnected state, and the corresponding mode indicator light will flash, indicating that the module is in command mode. The UART port is enabled, allowing commands to be sent for parameter configuration and queries.

For all device commands, the return results are consistent:

If the command is sent successfully, it returns: 54544D3A4F4B0D0A00 (TTM: OK\r\n\0)

If the command fails, it returns: 54544D3A4552500D0A00 (TTM: ERP\r\n\0)

After sending a valid setting command, parameters are applied immediately (note: baud rate settings only apply after a reset command is issued). However, these parameters are not retained on power down unless the reset command is sent, which saves them to flash memory.

Below is the list of configuration commands:



Note: The first and second lines of the command correspond to the HEX format and ASCII format, respectively. When querying parameters, all returned values are in hexadecimal, so commands need to be parsed using hexadecimal numbers.

The device is in master mode (blue light), the relevant parameters for the master mode include scan timeout, scan interval, and connection interval. The command for setting the connection interval applies to both master and slave modes. However, scan timeout and scan interval are only effective in master mode.

Function	Command (hex/ASCII)	Description
Set scan Timeout	54544D3A5343542D<Para> TTM:SCT-<Para>	Length: 1 Byte, Value: 0-36, Para*5S, 0 means scanning all the time and output scanning result in real time.
Set Scan Timeout	54544D3A5343543F TTM:SCT?	Return TTM:SCT-<Para>\r\n\0, Para: Hexadecimal
Set Scan Interval	54544D3A5349572D<Para> TTM:SIW-<Para>	Length: 1 Byte, Value: 0-100, Para*10mS
Query Scan Interval	54544D3A5349573F TTM:SIW?	Return TTM:SIW-<Para>\r\n\0, Para: Hexadecimal
Set RSSI Filtering	54544D3A5253492D<Para> TTM:RSI-<Para>	Value: -120 ~ -30dBm, if less than -100dBm, then disable RSSI filtering.
Query RSSI Filtering	54544D3A5253493F TTM:RSI?	Return TTM:RSI-<Para>\r\n\0, Para: Hexadecimal
Set Broadcast Name Filtering	54544D3A404E462D<Para> TTM:AVF-<Para>	Length: 16 Byte, Value: ASCII code
Query Broadcast Name Filtering	54544D3A404E463F TTM:ANF?	Return TTM:ANF-<Para>\r\n\0, Para: Hexadecimal Para is the filter value for the previously set broadcast name. If not enabled, Para is empty.
Cancel Broadcast Name Filtering	54544D3A404E462D TTM:ANF-	Cancel broadcast name filtering
Setting MAC Address Filtering	54544D3A4D41462D<Para> TTM:MAF-<Para>	Length: 6 Byte, value: hexadecimal number Set the MAC address filter value to Para. Only when the scanned device's MAC address matches the set value will the device information be output. When MAC address filtering is enabled, the scan results are output in real time. The output format is: 0xAA+MAC+RSSI+adv_data+0x0D0A. If no filtered devices are scanned, the following will be output: TTM:NO-DEVICE\r\n\0
Query MAC Address Filtering	54544D3A4D41463F TTM:MAF?	Return TTM:MAF-<Para>\r\n\0, Para: Hexadecimal If not enabled, Para is empty.
Cancel MAC address filtering	54544D3A4D41462D	Cancel MAC address filtering



Note: To make it easier to find the device, RSSI, broadcast name, and MAC address filtering features have been added. Only one of MAC address filtering or broadcast name filtering can be active at a time. Enabling MAC address filtering will automatically disable broadcast name filtering, and enabling broadcast name filtering will automatically disable MAC address filtering.

When functioning as a master, the device needs to send specific commands to enable Bluetooth operations, such as scanning and initiating a connection to a particular device. Once connected, during data transmission, all data packets are checked to determine if they contain a disconnect command.

Function	Command (hex/ASCII)	Description
Turn On Scanning	54544d3a5343414e TTM:SCAN	Correct command response: TTM:SCANNING\r\n\r\n0, error response TTM:ERP\r\n\r\n0. After the scan times out, output the device information of devices that can be connected and have broadcast names. The output format is as follows: XXXXXXXXXXXX Minew_V5.44H\r\n XXXXXXXXXXXX Minew_V5.43H\r\n XXXXXXXXXXXX Minew_V5.42H\r\n Note: When the scan timeout is non-zero, the output results are sorted by RSSI from strongest to weakest, with a maximum of 10 device information entries. If no devices are scanned, the output is: 000000000000 \r\n; When the scan timeout is zero or MAC address filtering is enabled, the scan results are output in real-time. The output format is: 0xAA+MAC+RSSI+adv_data+0x0D0A.
Stop Scanning	54544d3a5343414e2d53544f50 TTM:SCAN-STOP	The command returns correctly: TTM:S-CAN-STOP\r\n\r\n0, incorrectly returns TTM:ERP\r\n\r\n0
Connect to the Specified MAC	54544D3A434F4E4E2D <MAC> TTM:CONN-<MAC>	Command return: TTM:CONNING\r\n\r\n0, indicating connection in progress TTM:CONN-TOUT\r\n\r\n0, connection timeout TTM:NO-DEVICE\r\n\r\n0, device not found TTM:CONN-MAC-XXXXXXXXXXXX\r\n\r\n0, connected TTM:MAC-DCON-XXXXXXXXXXXX\r\n\r\n0, Disconnect TTM:ERP\r\n\r\n0, Command Error
Disconnect All Connections	54544D3A444953432D414C4C TTM:DISC-ALL	This command is only effective after connection. Correctly return TTM:DISC-XXXXXXXXXXXX XXX\r\n\r\n0, incorrectly return TTM:ERP\r\n\r\n0



Note: The above commands are only effective in master mode. If the device is not in master mode, sending these commands will return TTM:ERP\r\n\r\n0. For all other device commands, regardless of whether in master or slave mode, as long as the parameter requirements are met, the response will be TTM:OK\r\n\r\n0, and the parameters will take effect in the corresponding role.

In master mode, the device can initiate a connection to a specified slave device using its MAC address, entering connection mode directly. When the MAC address of the target device is known, scanning is not necessary; you can simply send the connection command.

When switching from master mode to slave mode, the device must first ensure it is in an unconnected state. You should invoke the command to set the role, followed by the reset command to successfully switch to the slave role, and vice versa.

Function	Command (hex/ASCII)	Description
Set Role	54544D3A524F4C2D <Para> TTM:ROL-<Para>	Length: 1 Byte, Value: 0-1, 0 for slave mode, 1 for master mode
Query Role	54544d3a524f4c3f TTM:ROL?	Return to TTM:ROL-<Para>\r\n\r\n0, Para: Hexadecimal

When in slave mode, you can set and query many parameters of the broadcast process and connection process as follows:

Function	Command (hex/ASCII)	Description
Set Broadcast Name	54544D3A52454E2D <Para> TTM:REN-<Para>	Length: 1-16 Byte, Value: ASCII
Query Broadcast Name	54544d3a52454e3f TTM:REN?	Return TTM:REN-<Para>\r\n\0, Para is ASCII
Set Broadcast Interval	54544D3A4144502D <Para> TTM:ADP-<Para>	Length: 1 Byte, value: 1-20, corresponding to broadcast interval 1*100ms. Note: Do not add zeros before the significant digits when representing strings. The larger the broadcast interval, the lower the power consumption. The maximum broadcast interval is 2 seconds.
Query Broadcast Interval	54544D3A4144503F TTM:ADP?	Return TTM:ADP-<Para>\r\n\0, Para: Hexadecimal
Set Transmitting Power	54544D3A54504C2D <Para> TTM:TPL-<Para>	Length: 1 Byte, Values: 0-8, corresponding to -40, -20, -16, -12, -8, -4, 0, +4, +8 (unit: dBm)
Query Transmitting Power	54544D3A54504C3F TTM:TPL?	Return TTM:TPL-<Para>\r\n\0, Para: Hexadecimal
Set Broadcast Data	54544D3A4144442D <Para> TTM:ADD-<Para>	Length: 1-16 Byte, value: any hexadecimal number
Query Broadcast Data	54544D3A4144443F TTM:ADD?	Return TTM:ADD-<Para>\r\n\0, Para: Hexadecimal
Set Factory ID	54544D3A5049442D <Para> TTM:PID-<Para>	Length: 2 Byte, value: any hexadecimal number
Query Factory ID	54544D3A5049443F TTM:PID?	Return TTM:PID-<Para>\r\n\0, Para: Hexadecimal
Set Service UUID	54544D3A5549442D <Para> TTM:UID-<Para>	Length: 6Byte, (2 Byte service uuid+2 Byte rx UUID+2 Byte tx UUID) Values: Any hexadecimal number, service, rx, tx UUID can't be the same.
Query Service UUID	54544D3A5549443F TTM:UID?	Return TTM:UID-<Para>\r\n\0, Para: Hexadecimal

Function	Command (hex/ASCII)	Description
Set Broadcast Mode	54544D3A4D4F442D <Para> TTM:MOD-<Para>	Set device broadcast packet format: 0: pass-through broadcast packet 1: iBeacon broadcast packet, you can see the specific broadcast packet format instructions
Query Broadcast Mode	54544d3a4d4f443f TTM:MOD?	Return TTM:MOD-<Para>\r\n0, Para: Hexadecimal
Set UUID	54544D3A4149442D <Para> TTM:AID-<Para>	Length: 16 bytes, value: any hexadecimal number
Query UUID	54544D3A4149443F TTM:AID?	Return TTM:AID-<Para>\r\n0, Para: Hexadecimal
Set Major	54544D3A4D414A2D<Para> TTM:MAJ-<Para>	Length: 2 bytes, value: any hexadecimal number
Query Major	54544D3A4D414A3F TTM:MAJ?	Return to TTM:MAJ-<Para>\r\n0, Para: Hexadecimal
Set Minor	54544D3A4D494E2D <Para> TTM:MIN-<Para>	Length: 2 bytes, value: any hexadecimal number
Query Minor	54544d3a4d494e3f TTM:MIN?	Return TTM:MIN-<Para>\r\n0, Para: Hexadecimal
Set Connection Mode	54544D3A5057452D <Para> TTM:PWE-<Para>	Whether the device requires a password to connect, 0: no password required to connect 1: Connection password required (Only valid from the end, when turned on, enter the correct password after 5 seconds of connection, otherwise the connection will be disconnected)
Query Connection Mode	54544D3A5057453F TTM:PWE?	Return TTM:PWE-<Para>\r\n0, Para: Hexadecimal
Set Connection Password	54544D3A5057442D <Para> TTM:PWD-<Para>	Length: 1-8 bytes, value: ASCII, the correct password must be entered within 5s on the connection, otherwise the connection will be disconnected
Query Connection Password	54544D3A5057443F TTM:PWD?	Return to TTM:PWD-<Para>\r\n0, Para:ASCII

Regardless of whether in master mode or slave mode, all configuration commands require a reset command to take effect. Query commands will return the relevant parameters, while erroneous commands will return TTM:ERP\r\n0.

For the device as a whole, commands for baud rate and connection interval are effective in both master and slave modes.

Function	Command (hex/ASCII)	Description
Set Baud Rrate	54544D3A4250532D <Para> TTM:BPS-<Para>	Length: 1 Byte, Values: 0-4, corresponding to 9600/ 19200/38400/57600/115200 (unit: bps) respectively.
Query Baud Rate	54544D3A4250533F TTM:BPS?	Return TTM:BPS-<Para>\r\n\0, Para: Hexadecimal
Set Connection Interval	54544D3A4349542D <Para> TTM:CIT-<Para>	Length: 1 byte, can only be represented in hexadecimal as 0x01 to 0x64; The actual connection interval is (Para*10 to Para*10+20) ms.
Query Connection Interval	54544D3A4349543F TTM:CIT?	Return to TTM:CIT-<Para>\r\n\0, Para: Hexadecimal
Read MAC Address	54544d3a4d4143(2d)3f TTM:MAC-? or TTM:MAC?	Return TTM:MAC-<Para>\r\n\0, Para: Hexadecimal
Read Version Information	54544d3a564552(2d)3f TTM:VER-? or TTM:VER?	Return to TTM:VER-<Para>\r\n\0, Para:ASCII
Restore Factory Settings	54544d3a5253542d464143 TTM:RST-FAC	Consistent with the return of the setup command
Reset	54544d3a5253542d535953 TTM:RST-SYS	Success will return TTM:OK\r\n\0
Set Serial Port Parity Bit	54544D3A5041522D <Para> TTM:PAR-[X]	Set whether parity is enabled. X can be represented in hexadecimal as 0x00 to 0x01 or as a string from "0" to "1", with a length of 1 byte. 0: Disabled, 1: Enabled Note: After successfully resetting the settings, the host computer (serial port assistant) must also be modified to set even parity.
Query Serial Port Parity Bit	54544D3A5041523F TTM:PAR?	Check whether the serial port parity bit is enabled. Return: TTM:PAR-[X]\r\n\0, where X is represented in hexadecimal.

## 6.2 Operation Examples

### 6.2.1 Factory Default Parameters

Broadcast Name: Minew\_Vxxxxx  
 Serial port baud rate: 9600bps,8N1  
 Transmit power: 0dBm  
 Minimum and maximum connection interval: 20ms - 40ms  
 Device Role: Master  
 Default parameters related to master mode:  
 Scanning timeout: 10s  
 Scanning interval: 100ms

Default parameters related to slave mode:  
 Broadcast interval: 1s  
 Broadcast mode: transparent broadcast package  
 Custom data: MinewTech  
 Connection password enable: not enabled  
 Connection password: minew123  
 Major: 0x1234  
 minor: 0x1235  
 UUID: 74278BDA-B644-4520-8F0C-720EAF059935



## 6.2.2 Parameter Modification Example

After powering on the dongle, the device enters the unconnected state, during which parameters can be configured. Regardless of whether the device is in master mode or slave mode, all parameters can be set and will take effect immediately. However, the applied parameters are only reflected in the corresponding role. For example, if the broadcast name is modified while in master mode, the parameter takes effect, but the change will only be visible once the device switches to slave mode. After sending the reset command, all parameters will be saved and retained after power-off.



Note: When multiple parameters need to be modified, you can send all the setting commands first and then send the reset command.

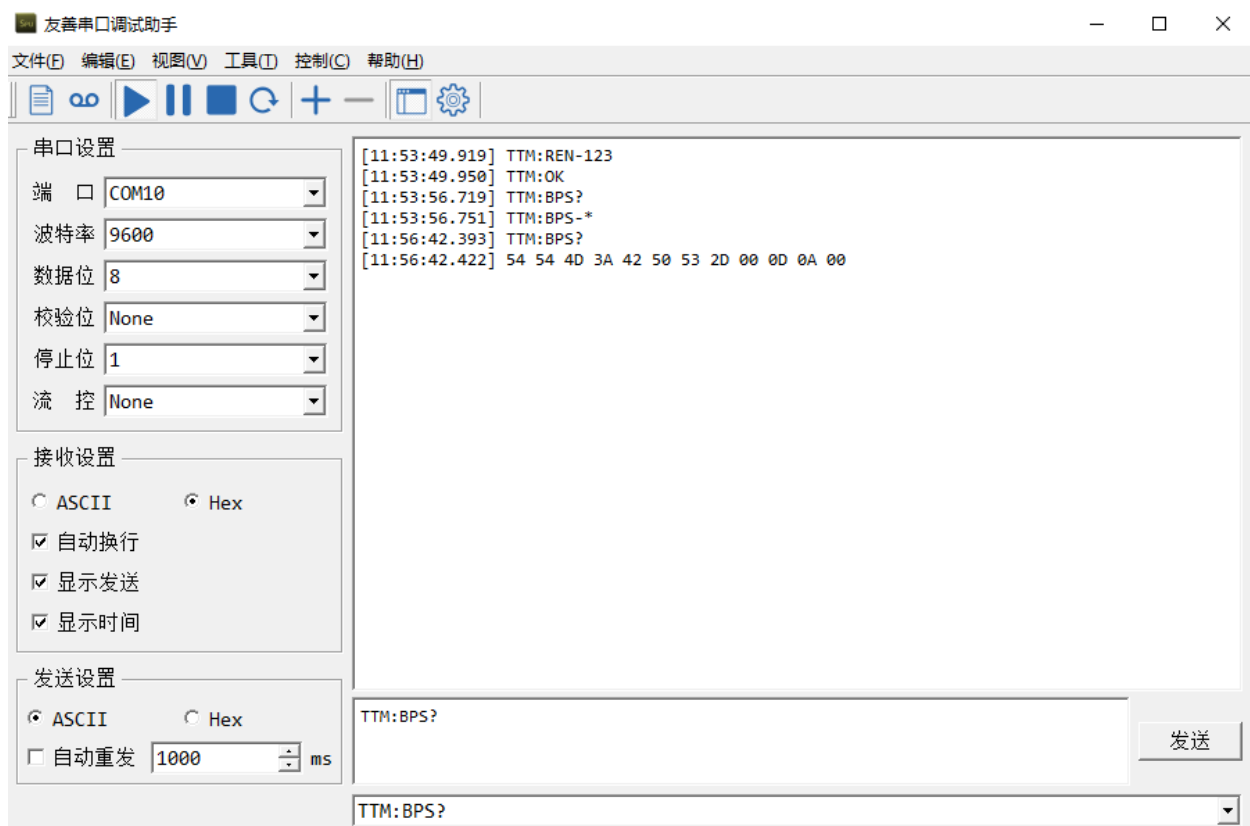

When querying device parameters, the values are in hexadecimal format. If ASCII display is selected, the parameter positions may appear as garbled text. In this case, you should set it to HEX display. The parameters will correspond to the positions after "2D" in the output. To check the baud rate, make sure to use HEX display to view the specific parameters.

## 6.2.3 Scanning and Connecting to Devices

Send the 54544D3A5343414E (TTM:SCAN) command to scan for a device and obtain its MAC address. The scanned device returns MAC + broadcast name information. Send the 54544D3A434F4E4E2D201907230857 command and the module will connect the device with MAC address 20:19:07:23:08:57. The device connected will return TTM:CONN-MAC-XXXXXXXXXXXXXXXX\r\n0. Since MAC is a hexadecimal number, the entire command is sent as a hexadecimal number. Once connected you can perform data passthrough.

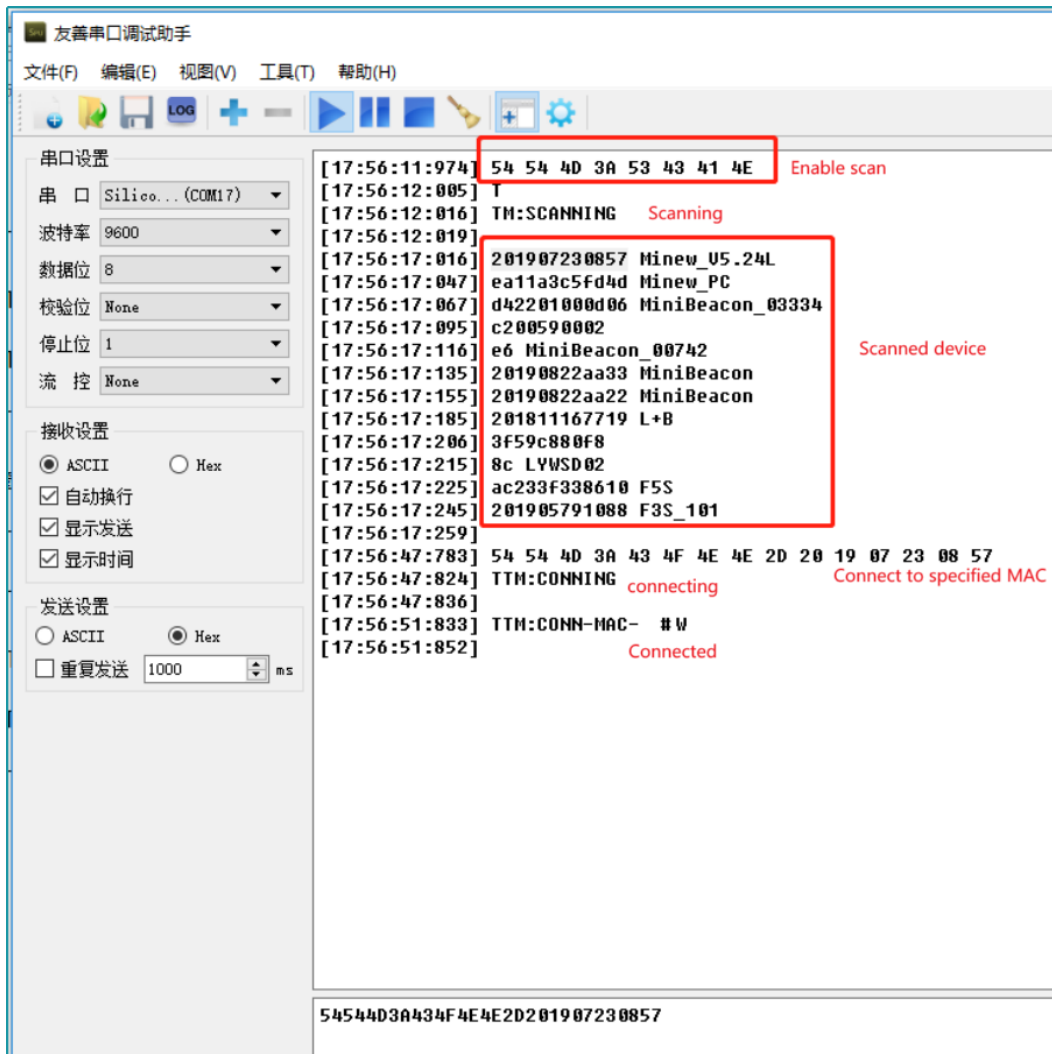

### 6.2.4 Master Pass-Through

Data passthrough is possible after the connected command is returned in step 6.2.3. The prerequisite for correct communication between the module and the slave device is that the slave device must have the same services, features, and their UUIDs and attributes as the module.

Relevant information is provided below:

Eigenvalue UUID	Executable operation	Packet length	Note
FFF1	notify	244	Module data reception, the data sent from the device to the module shall not exceed 244 Byte per packet.
FFF2	write	244	Module data sending, the module has to do automatic packetization, data more than 244 Byte will be automatically divided into 244 packets sent to the slave device.

As an example, the master module connects to the passthrough slave module, and then sends the data after connecting.

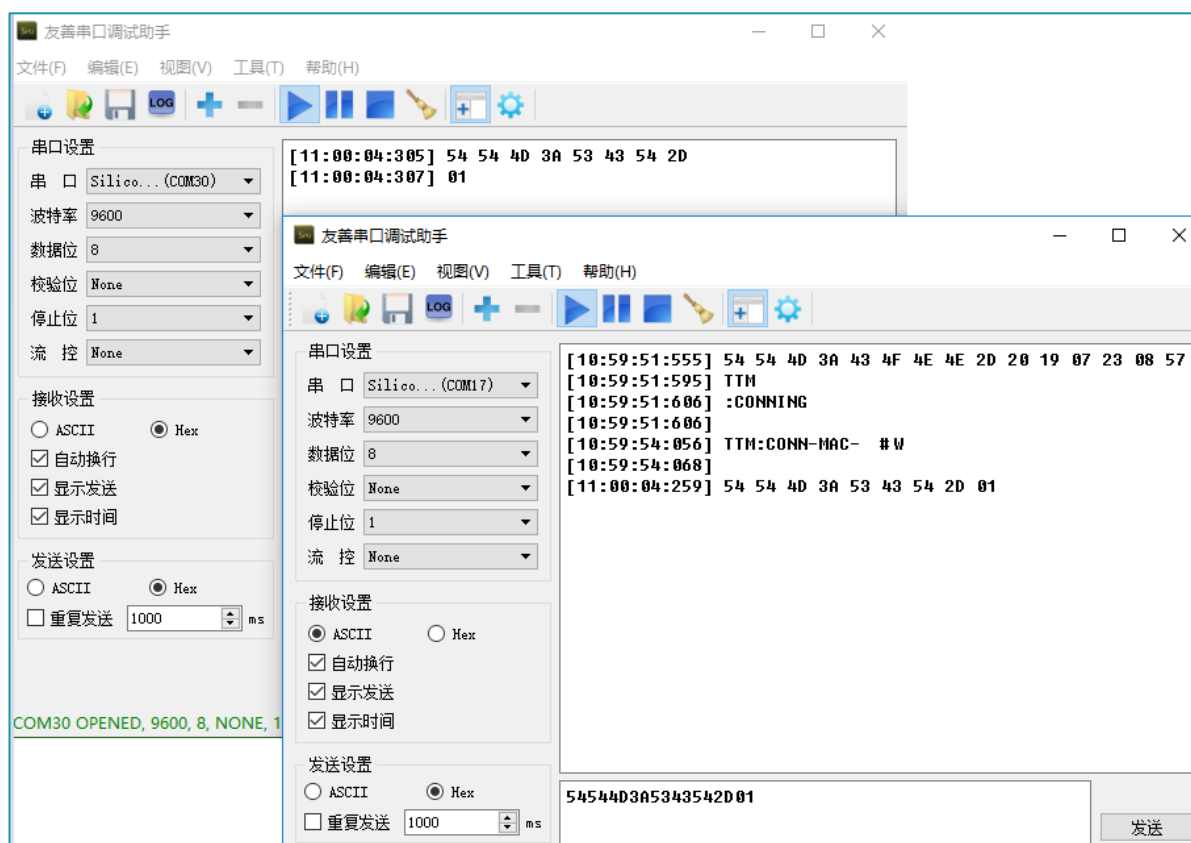

### 6.2.5 Slave Broadcasting

After setting the device role to slave mode using the command TTM:ROL-0, data pass-through can occur with a mobile phone. The device is in broadcast mode.

Using the nRF Connect app, you can scan for devices. Once the device is detected, click on "Raw" to view the raw data, which is the unparsed data from the scan. After parsing according to BLE data types, you can refer to the Details section.

BLE broadcast data follows a specific format: Length + Type + Content. The content can vary, while the type is fixed, and the length is determined by the content. The device has two broadcast formats: pass-through broadcast packets and iBeacon broadcast packets. Both formats include four types: Flag (0x01), Broadcast Name (0x09), Service Data (0x16), and Manufacturer Data (0xFF).

The diagram below shows the pass-through broadcast packet: Flag, Broadcast Name, and Service Data are included in the broadcast data packet, while Manufacturer Data is found in the response data packet. The content of the Service Data includes the Service Data UUID (E1FF) and MAC Address. The Manufacturer Data consists of the Company ID (3906), Battery Level Information (1 byte), and Custom Data.

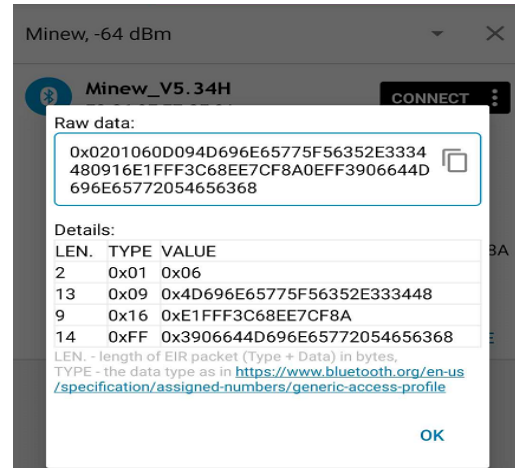
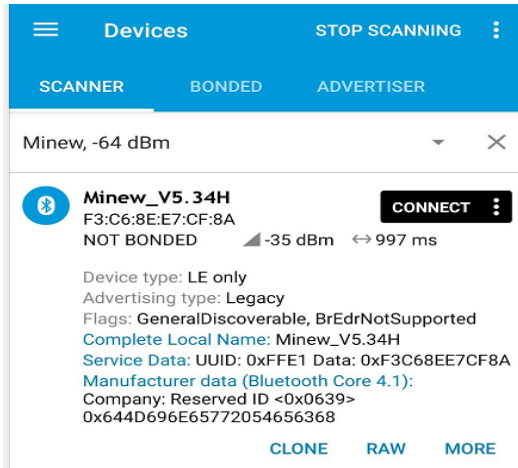

 Note: The iOS side cannot access the MAC address field, so the MAC address is placed back into the broadcast packet to ensure that the iOS app can retrieve the device's MAC address. Additionally, WeChat Mini Programs cannot access the response data packet, so the MAC address is included in the service data of the broadcast packet to ensure that iOS devices using WeChat Mini Programs can also obtain the device's MAC address.

The diagram below shows the iBeacon broadcast packet: Flag and Manufacturer Data are included in the broadcast data packet, while Service Data and Broadcast Name are found in the response data packet. The broadcast data packet must follow this fixed format to comply with the iBeacon protocol definition.

In the Manufacturer Data, 4C 00 represents Apple's Company ID, and 02 15 is the fixed format for iBeacon, followed by the Proximity UUID (16 bytes), Major (2 bytes), Minor (2 bytes), and Measured Power (1 byte).

In iBeacon broadcast mode, the Manufacturer Data can only have the Proximity UUID, Major, and Minor values modified.

The Service Data consists of the Service Data UUID (FFE1), Battery Level Information, and MAC Address.

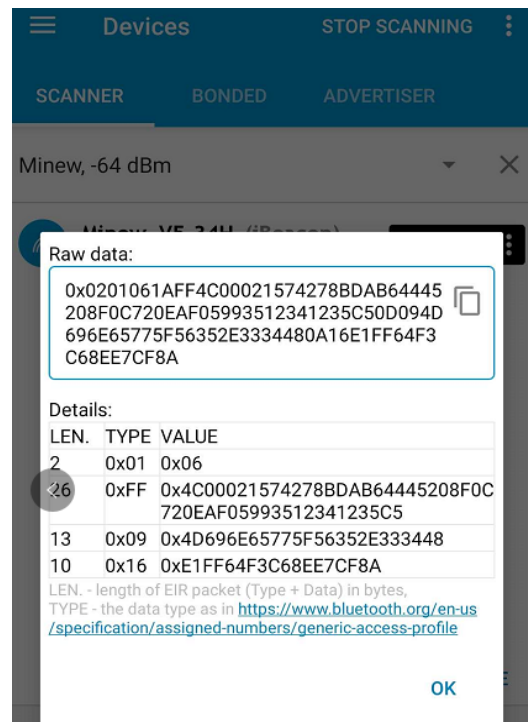
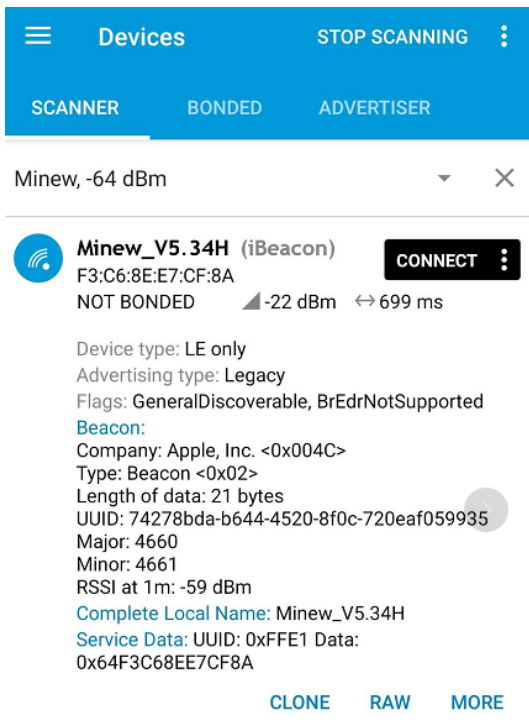

## 6.2.6 Slave Pass-Through

Based on 6.2.5, when connecting the device using a mobile app, keep the BTDATA pin low to enable data pass-through. If BTDATA is not low, it does not affect the device's broadcasting and connection capabilities; it simply prevents pass-through functionality.

Using nRF Connect, you can view the specific Service, Characteristic, and their corresponding Properties.

The UUID consists of an Alias UUID (2 bytes, located at the 3rd and 4th bytes in the figure) combined with a Base UUID (the remaining 14 bytes). In the pass-through program, the services and characteristics utilize a standard base UUID, and the following explanation will use the Alias UUID for clarification.

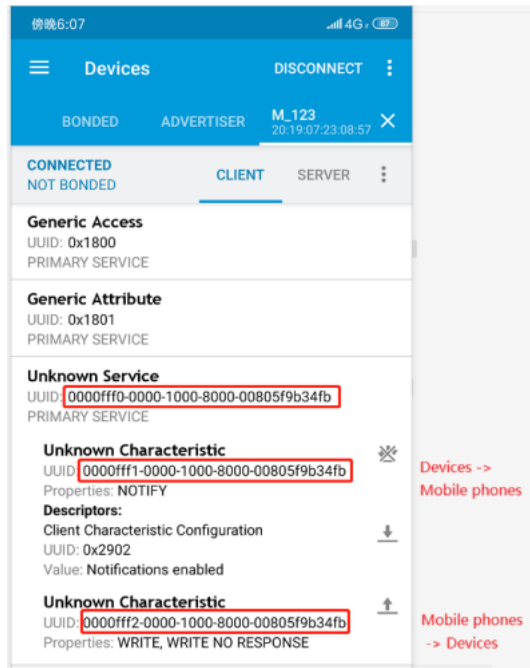

FFF0 is the Service UUID.

FFF1 is for data received by the phone, with the module sending data.

FFF2 is for data sent by the phone, with the module receiving data

Eigenvalue UUID	Executable operation	Maximum Packet Length	Note
FFF1	notify	244	When sending data to the module via the serial interface, the module will forward it to the phone. The phone must enable notifications to receive the data. The maximum packet size that the module can send in one transmission is 244 bytes. Note: The firmware automatically handles packet fragmentation, so there is no need to manually divide the data into packets based on the maximum length. However, each packet must not exceed 10 kB, and you should consider the transmission rate to avoid issues such as packet loss or disconnection.
FFF2	write	244	The phone sends data to the module and forwards it to the serial port. When using the API interface function to write data, the maximum length of data written at one time is 244 bytes

## 6.3 OTA Operating Instructions

### 6.3.1 Configuring the nRF Connect App

If not configured, the upgrade will erase all user data stored in flash memory.

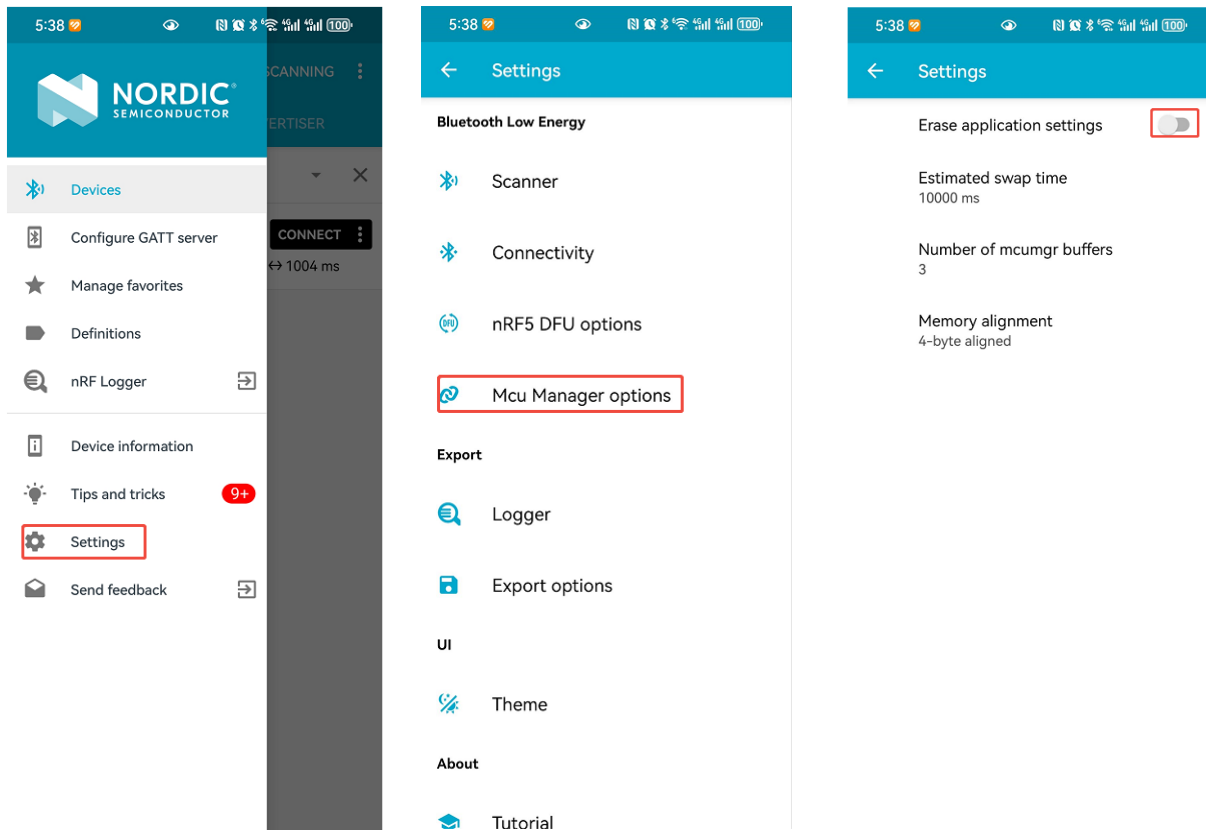

Android Operation Diagram

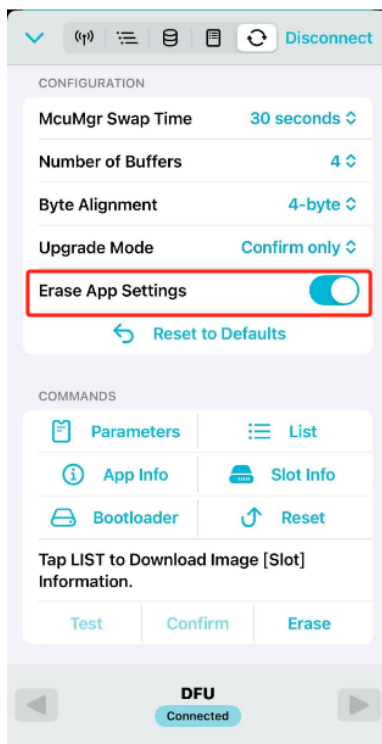

Note: iOS devices require a connection before configuration.

## 6.3.2 Connecting and Performing the Upgrade

### 1. Connecting devices

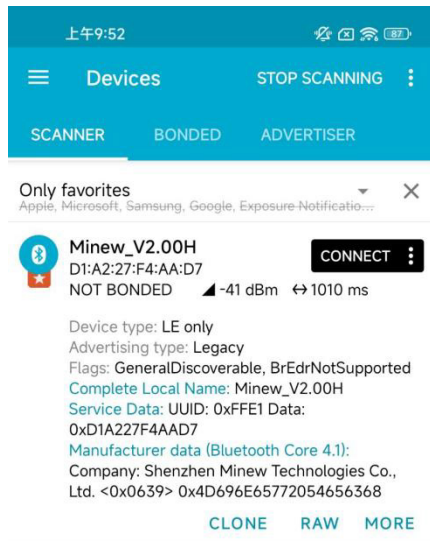

### 2. Select Upgrade Type

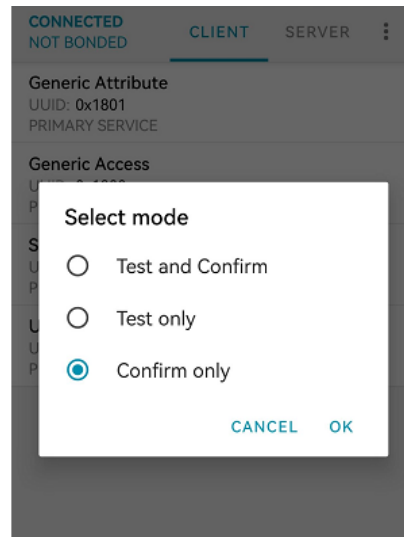

### 3. Select the upgrade package in the upper-right corner DFU

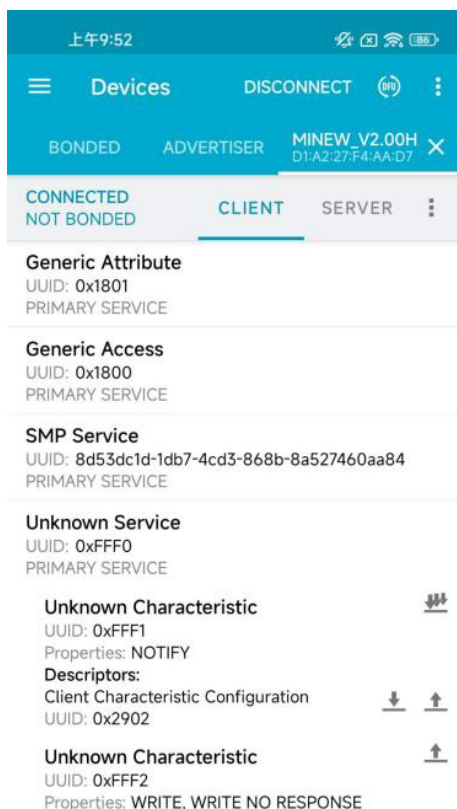

### 4. Begin upgrade

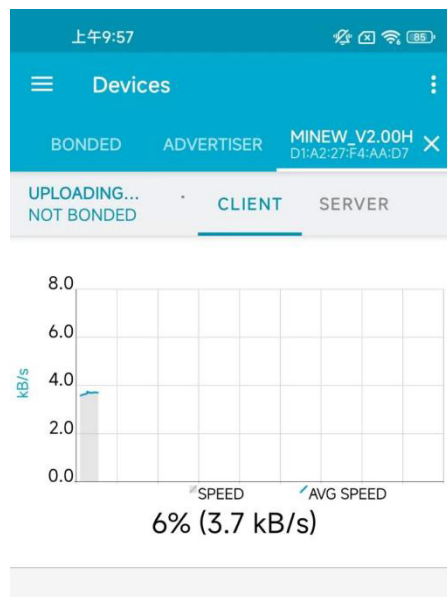

The device will restart approximately 2~30 seconds after the upgrade is completed (depending on the size of the firmware being upgraded).

# 7 MECHANICAL DRAWING

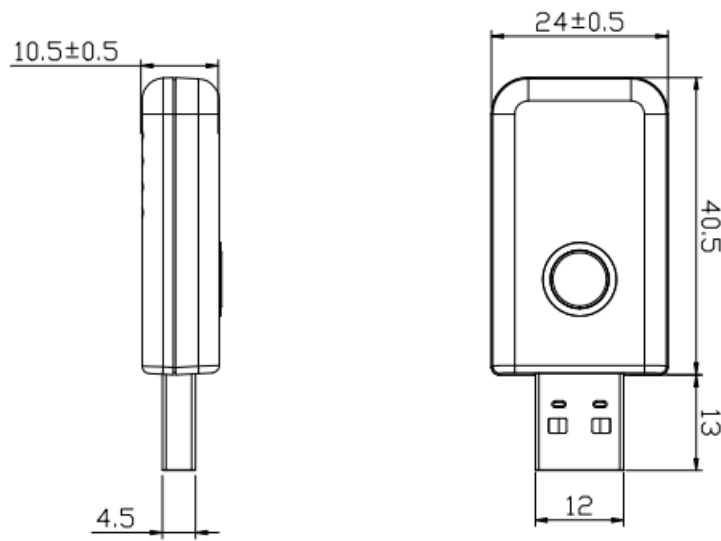

Default unit: mm Default tolerance: ±0.5

# 8 ELECTRICAL SCHEMATIC

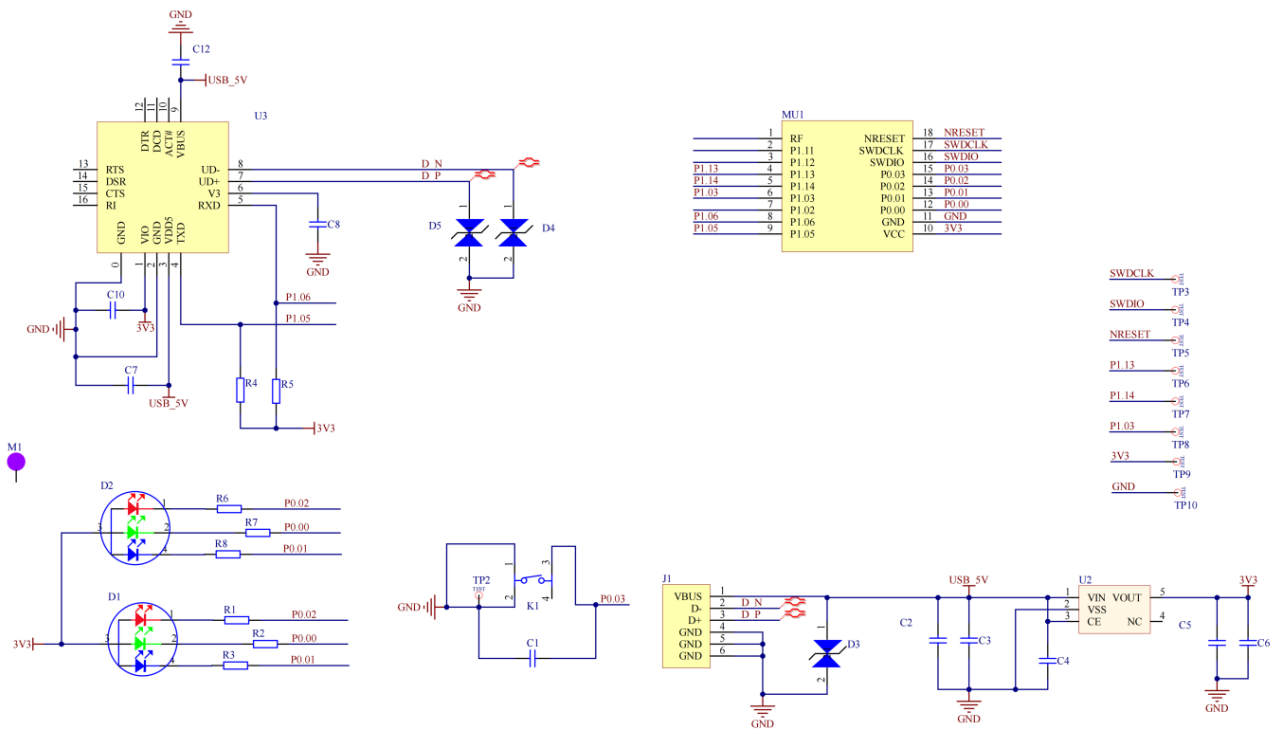

Notice: Before placing an order, please confirm the specific configuration required with the salesperson.

## 9 PACKAGE INFORMATION

Product	Packaging Bag	Inner Box	Outer Carton
		 64 PCS/box, Inner box dimensions: 306*110*72mm	 64 PCS/box, 10 boxes/carton Outer carton dimensions: 320 x 230 x 400 mm

Packaging Detail	Inner box Specification	Product Net Weight	Gross Weight (Inner Box)
Quantity	64PCS	9.2g	700g

## 10 STORAGE CONDITIONS

- **Please use this product within 6 months after signing the receipt.**
  - This product should be stored without opening the package at an ambient temperature of 5~35°C and a humidity of 20~70%RH.
  - This product should be left for more than 6 months after receipt and should be confirmed before use.
  - The product must be stored in a non-corrosive gas (Cl2, NH3, SO2, NOx, etc.).
  - To avoid damaging the packaging material, do not apply any excessive mechanical shocks, including but not limited to sharp objects adhering to the packaging material and product dropping.
- **This product is suitable for MSL2 (based on JEDEC standard J-STD-020).**
  - After opening the package, the product must be stored at ≤30°C/<60%RH. It is recommended to use the product within 3-6 months after opening the package.
  - When the color of the indicator in the package changes, the product should be baked before welding.
- **Baking is not required for one year if exposure is limited to <30°C and 60%RH. Refer to MSL2 for exposure criteria for moisture sensitivity level. If exposed to (≥168h@85°C/60%RH) conditions or stored for more than one year, recommended baking conditions.**
  1. 120 +5/-5°C, 8 hours, 1 time  
Products must be baked individually on heat-resistant trays because the materials (base tape, reel tape, and cover tape) are not heat-resistant, and the packaging material may be deformed at temperatures of 120°C;
  2. 90°C +8/-0°C, 24hours, 1times  
The base tape can be baked together with the product at this temperature. Please pay attention to the uniformity of heat.

## 11 HANDLING CONDITIONS

- Be careful in handling or transporting products because excessive stress or mechanical shock may break products.
- Handle with care if products may have cracks or damages on their terminals. If there is any such damage, the characteristics of products may change. Do not touch products with bare hands that may result in poor solder ability and destroy by static electrical charge.

## 12 QUALITY

Cognizant of our commitment to quality, we operate our own factory equipped with state-of-the-art production facilities and a meticulous quality management system. We hold certifications for ISO9001, ISO14001, ISO27001, OHSAS18001, BSCI.

Every product undergoes stringent testing, including transmit power, sensitivity, power consumption, stability, and aging tests. Our fully automated module production line is now in full operation, boasting a production capacity in the millions, capable of meeting high-volume production demands.

## 13 COPYRIGHT STATEMENT

This manual and all the contents contained in it are owned by Shenzhen Minewsemi Co., Ltd. and are protected by Chinese laws and applicable international conventions related to copyright laws.

The certified trademarks included in this product and related documents have been licensed for use by MinewSemi. This includes but is not limited to certifications such as BQB, RoHS, REACH, CE, FCC, BQB, IC, SRRC, TELEC, WPC, RCM, WEEE, etc. The respective textual trademarks and logos belong to their respective owners. For example, the Bluetooth® textual trademark and logo are owned by Bluetooth SIG, Inc. Other trademarks and trade names are those of their respective owners. Due to the small size of the module product, the "®" symbol is omitted from the Bluetooth Primary Trademarks information in compliance with regulations.

The company has the right to change the content of this manual according to the technological development, and the revised version will not be notified otherwise. Without the written permission and authorization of the company, any individual, company, or organization shall not modify the contents of this manual or use part or all of the contents of this manual in other ways. Violators will be held accountable in accordance with the law.

## 14 RELATED DOCUMENTS

- [MinewSemi\\_Product\\_Naming\\_Reference\\_Manual](https://en.minewsemi.com/file/MinewSemi_Product_Naming_Reference_Manual_EN.pdf)  
[https://en.minewsemi.com/file/MinewSemi\\_Product\\_Naming\\_Reference\\_Manual\\_EN.pdf](https://en.minewsemi.com/file/MinewSemi_Product_Naming_Reference_Manual_EN.pdf)
- [MinewSemi\\_Connectivity\\_Module\\_Catalogue](https://en.minewsemi.com/file/MinewSemi_Connectivity_Module_Catalogue_EN.pdf)  
[https://en.minewsemi.com/file/MinewSemi\\_Connectivity\\_Module\\_Catalogue\\_EN.pdf](https://en.minewsemi.com/file/MinewSemi_Connectivity_Module_Catalogue_EN.pdf)



For product change notifications and regular updates of Minewsemi documentation, please register on our website: [www.minewsemi.com](http://www.minewsemi.com)

**MINEWSEMI**  
Innovative IoT Module Expert



### SHENZHEN MINEWSEMI CO., LTD.



0086-755-2801 0353



<https://minewsemi.com>



[minewsemi@minew.com](mailto:minewsemi@minew.com)



<https://store.minewsemi.com>



Gangzhihong Technology Park, Qinglong Road, Longhua District, Shenzhen